

Optical switches

Switching Technology S38.3165
<http://www.netlab.hut.fi/opetus/s383165>

Optical switches

- **Components and enabling technologies**
- **Contention resolution**
- **Optical switching schemes**

Components and enabling technologies

- Optical fiber
- Light sources, optical transmitters
- Photodetectors, optical receivers
- Optical amplifiers
- Wavelength converters
- Optical multiplexers and demultiplexers
- Optical add-drop multiplexers
- Optical cross connects
- WDM systems

Optical fiber

- Optical fiber is the most important transport medium for high-speed communications in fixed networks
- Pros
 - immune to electromagnetic interference
 - does not corrode
 - huge bandwidth (25 Tbit/s)
- Cons
 - connecting fibers requires special techniques (connectors, specialized personnel to splice and connect fibers)
 - does not allow tight bending
- An optical fiber consists of
 - ultrapure silica
 - mixed with dopants to adjust the refractive index

Optical fiber (cont.)

- Optical fiber consists of several layers
 - silica core
 - cladding, a layer of silica with a different mix of dopants
 - buffer coating, which absorbs mechanical stresses
 - coating is covered by a strong material such as Kevlar
 - outermost is a protective layer of plastic material

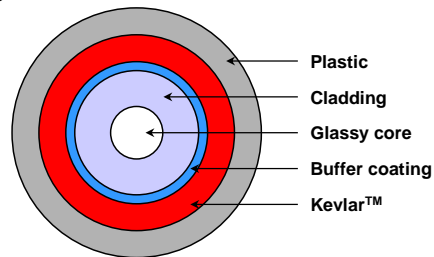

Cross section (not to scale)

Optical fiber (cont.)

- Fiber cable consists of a bundle of optical fibers, up to 432 fibers.
- Refractive index profile of a fiber is carefully controlled during manufacturing phase
- Typical refractive index profiles
 - step index profile
 - graded index profile

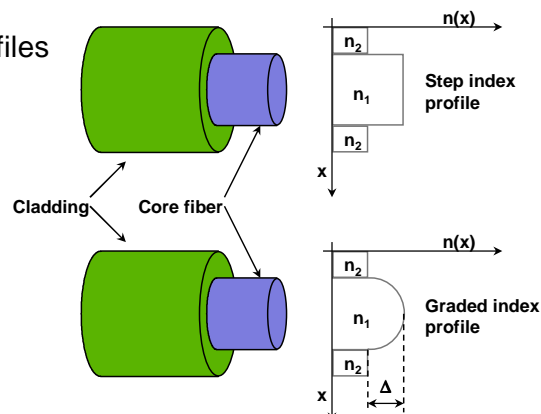

Optical fiber (cont.)

- Light beams are confined in the fiber
 - by total reflection at the core-cladding interface in step-index fibers
 - by more gradual refraction in graded index fibers

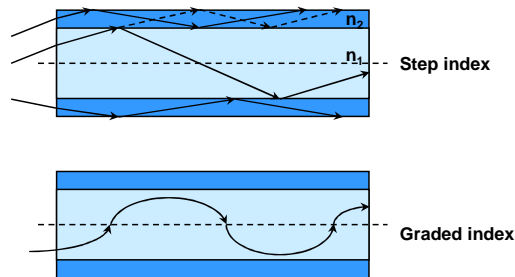

Optical fiber (cont.)

- Fiber can be designed to support
 - several propagation modes => multimode fiber
 - just a single propagation mode => single-mode fiber

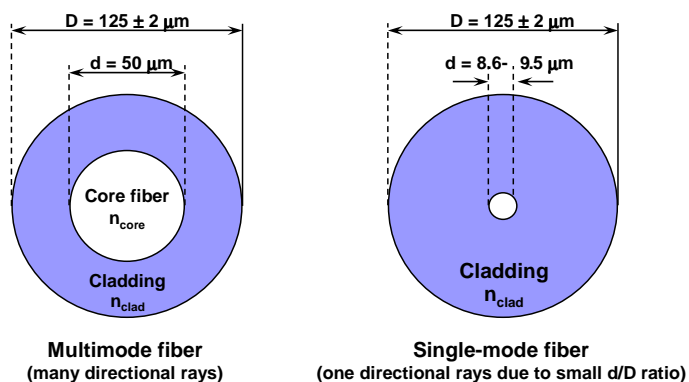

Optical fiber (cont.)

- **Multimode graded index fiber**
 - small delay spread
 - 1% index difference between core and cladding amounts to 1-5 ns/km delay spread
 - easy to splice and to couple light into it
 - bit rate limited up to 100 Mbit/s for lengths up to 40 km
 - fiber span without amplification is limited
- **Single mode fiber**
 - almost eliminates delay spread
 - more difficult to splice and to exactly align two fibers together
 - suitable for transmitting modulated signals at 40 Gbit/s or higher and up to 200 km without amplification

Optical fiber characteristics

- Dispersion is an undesirable phenomenon in optical fibers
 - causes an initially narrow light pulse to spread out as it propagates along the fiber
- There are different causes for dispersion
 - modal dispersion
 - chromatic dispersion
- Modal dispersion
 - occurs in multimode fibers
 - caused by different (lengths) propagation paths of different modes
- Chromatic dispersion
 - material properties of fiber, such as dielectric constant and propagation constant, depend on the frequency of the light
 - each individual wavelength of a pulse travels at different speed and arrives at the end of the fiber at different time

Optical fiber characteristics (cont.)

- Chromatic dispersion (cont.)
 - dispersion is measured in ps/(nm*km), i.e. delay per wavelength variation and fiber length
- Dispersion depends on the wavelength
 - at some wavelength dispersion may be zero
 - in conventional single mode fiber this typically occurs at 1.3 μm
 - below, dispersion is negative, above it is positive
- For long-haul transmission, single mode fibers with specialized index of refraction profiles have been manufactured
 - dispersion-shifted fiber (DSF)
 - zero-dispersion point is shifted to 1.55 μm

Optical fiber characteristics (cont.)

- Fiber attenuation is the most important transmission characteristic
 - limits the maximum span a light signal can be transmitted without amplification
- Fiber attenuation is caused by light scattering on
 - fluctuations of the refractive index
 - imperfections of the fiber
 - impurities (metal ions and OH radicals have a particular effect)
- A conventional single-mode fiber has two low attenuation ranges
 - one at about 1.3 μm
 - another at about 1.55 μm

Optical fiber characteristics (cont.)

- Between these ranges is a high attenuation range (1.35-1.45 μm), with a peak at 1.39 μm , due to OH radicals
 - special fibers almost free of OH radicals have been manufactured
 - such fibers increase the usable bandwidth by 50%
 - the whole range from 1.335 μm to 1.625 μm is usable, allowing about 500 WDM channels at 100 GHz channel spacing

Optical fiber characteristics (cont.)

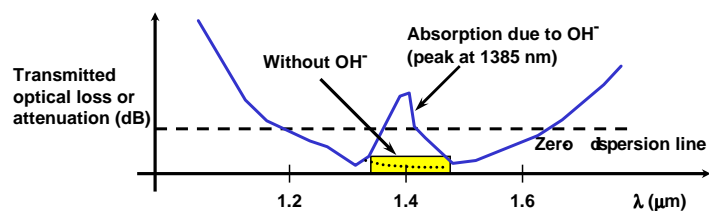

- Attenuation is measured in dB/km; typical values are
 - 0.4 dB/km at 1.31 μm
 - 0.2 dB/km at 1.55 μm
 - for comparison, attenuation in ordinary clear glass is about 1 dB/cm = 105 dB/km

Light sources and optical transmitters

- One of the key components in optical communications is the monochromatic (narrow band) light source
- Desirable properties
 - compact, monochromatic, stable and long lasting
- Light source may be one of the following types:
 - continuous-wave (CW); emits at a constant power; needs an external modulator to carry information
 - modulated light; no external modulator is necessary
- Two most popular light sources are
 - light emitting diode (LED)
 - semiconductor laser

Light emitting diode (LED)

- LED is a monolithically integrated p-n semiconductor diode
- Emits light when voltage is applied across its two terminals
- In the active junction area, electrons in the conduction band and holes in the valence band are injected
- Recombination of the electron with holes releases energy in the form of light
- Can be used either as a continuous-wave light source or modulated light source (modulated by the injection current)

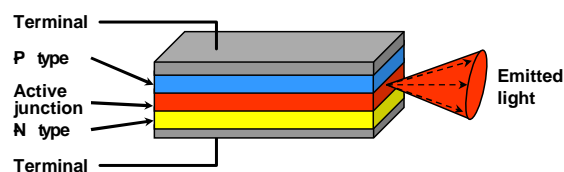

Characteristics of LED

- Relatively slow - modulation rate < 1 Gbit/s
- Bandwidth depends on the material - relatively wide spectrum
- Amplitude and spectrum depend on temperature
- Low cost
- Transmits light in wide cone - suitable for multimode fibers

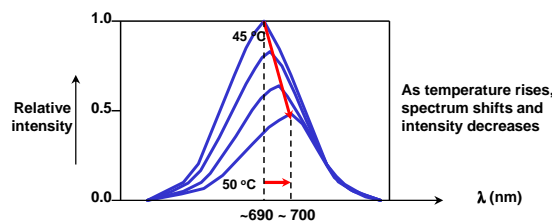

Semiconductor laser

- LASER (Light Amplification by Stimulated Emission of Radiation)
- Semiconductor laser is also known as **laser diode** and **injection laser**
- Operation of a laser is the same as for any other oscillator - gain (amplification) and feedback
- As a device, semiconductor laser is similar to a LED (i.e. p-n semiconductor diode)
- A difference is that the ends of the active junction area are carefully cleaved and act as partially reflecting mirrors
 - this provides feedback
- The junction area acts as a resonating cavity for certain frequencies (those for which the round-trip distance is multiple of the wavelength in the material - constructive interference)

Semiconductor laser (cont.)

- Light fed back by mirrors is amplified by **stimulated emission**
- Lasing is achieved above a **threshold current** where the optical gain is sufficient to overcome losses (including the transmitted light) from the cavity

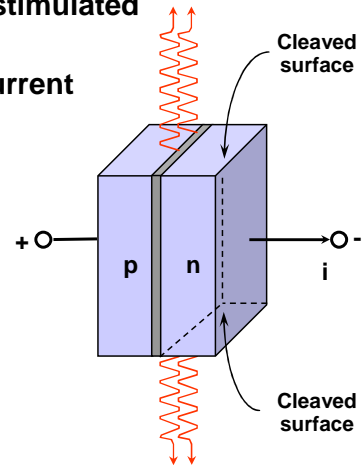

Semiconductor laser (cont.)

- Cavity of a Fabry-Perot laser can support many modes of oscillation => it is a multimode laser
- In single frequency operation, all but a single longitudinal mode must be suppressed - this can be achieved by different approaches:
 - cleaved-coupled cavity (C³) lasers
 - external cavity lasers
 - distributed Bragg reflector (DBR) lasers
 - distributed feedback (DFB) lasers
- The most common light sources for high-bit rate, long-distance transmission are the DBR and DFB lasers.

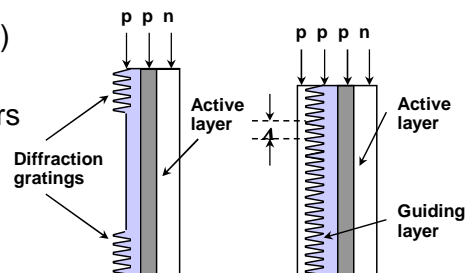

Semiconductor laser (cont.)

- Laser tunability is important for multiwavelength network applications
- Slow tunability (on ms time scale) is required for setting up connections in wavelength or waveband routed networks
 - achieved over a range of 1 nm via temperature control
- Rapid tunability (on ns- μ s time scale) is required for TDM-WDM multiple access applications
 - achieved in DBR and DFB lasers by changing the refractive index, e.g. by changing the injected current in grating area
- Another approach to rapid tunability is to use multiwavelength laser arrays
 - one or more lasers in the array can be activated at a time

Semiconductor laser (cont.)

- Lasers are modulated either directly or externally
 - direct modulation by varying the injection current
 - external modulation by an external device, e.g. Mach-Zehnder interferometer

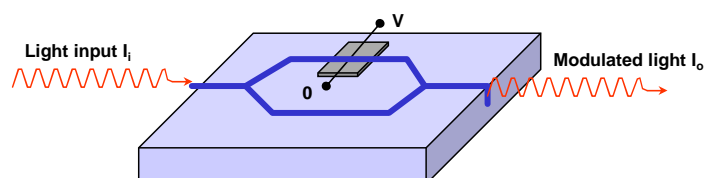

Mach-Zehnder interferometer

Photodetectors and optical receivers

- A photodetector converts the optical signal to a photocurrent that is then electronically amplified (front-end amplifier)
- In a direct detection receiver, only the intensity of the incoming signal is detected
 - in contrast to coherent detection, where the phase of the optical signal is also relevant
 - coherent systems are still in research phase
- Photodetectors used in optical transmission systems are semiconductor photodiodes
- Operation is essentially reverse of a semiconductor optical amplifier
 - junction is reverse biased
 - in absence of optical signal only a small minority carrier current is flowing (**dark current**)

Photodetectors and optical receivers (cont.)

- Operation is essentially reverse of a semiconductor optical amplifier (cont.)
 - a photon impinging on surface of a device can be absorbed by an electron in the valence band, transferring the electron to the conduction band
 - each excited electron contributes to the photocurrent
- PIN photodiodes (p-type, intrinsic, n-type)
- An extra layer of intrinsic semiconductor material is sandwiched between the p and n regions
- Improves the responsivity of the device
 - captures most of the light in the depletion region

Photodetectors and optical receivers (cont.)

- Avalanche photodiodes (APD)
- In a photodiode, only one electron-hole pair is produced by an absorbed photon
- This may not be sufficient when the optical power is very low
- The APD resembles a PIN
 - an extra gain layer is inserted between the i (intrinsic) and n layers
 - a large voltage is applied across the gain layer
 - photoelectrons are accelerated to sufficient speeds
 - produce additional electrons by collisions => avalanche effect
 - largely improved responsivity

Optical amplifiers

- Optical signal propagating in a fiber suffers attenuation
- Optical power level of a signal must be periodically conditioned
- Optical amplifiers are key components in long haul optical systems
- An optical amplifier is characterized by
 - **gain** - ratio of output power to input power (in dB)
 - **gain efficiency** - gain as a function of input power (dB/mW)
 - **gain bandwidth** - range of frequencies over which the amplifier is effective
 - **gain saturation** - maximum output power, beyond which no amplification is reached
 - **noise** - undesired signal due to physical processes in the amplifier

Optical amplifiers (cont.)

- Types of amplifiers
 - Electro-optic regenerators
 - Semiconductor optical amplifiers (SOA)
 - Erbium-doped fiber amplifiers (EDFA)

Electro-optic regenerators

- Optical signal is
 - received and transformed to an electronic signal
 - amplified in electronic domain
 - converted back to optical signal at the same wavelength

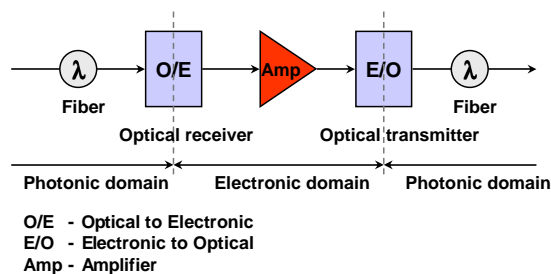

Semiconductor optical amplifiers (SOA)

- Structure of SOA is similar to that of a semiconductor laser
- It consists of an active medium (p-n junction) in the form of waveguide - usually made of InGaAs or InGaAsP
- Energy is provided by injecting electric current over the junction

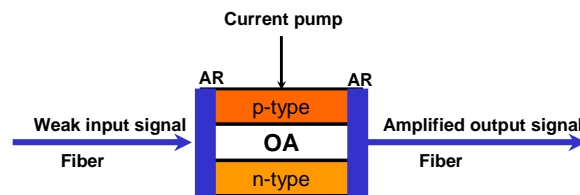

AR = Antireflection coating (to prevent undesirable reflections)
OA = Optical amplifier (active region)

Semiconductor optical amplifiers (cont.)

- SOAs are small, compact and can be integrated with other semiconductor and optical components
- They have large bandwidth and relatively high gain (20 dB)
- Saturation power in the range of 5-10 dBm
- SOAs are polarization dependent and thus require a polarization-maintaining fiber
- Due to non-linear phenomena, SOAs have a high noise figure and high cross-talk level

Erbium-doped fiber amplifiers (EDFA)

- EDFA is a very attractive amplifier type in optical communications systems
- EDFA is a fiber segment, a few meters long, heavily doped with erbium (a rare earth metal)
- Energy is provided by a pump laser beam

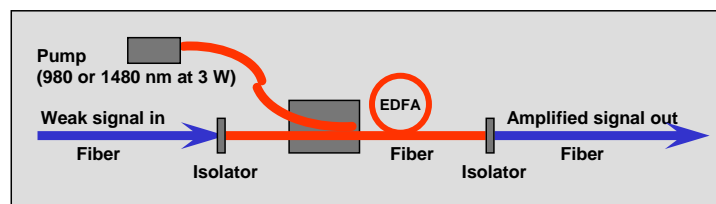

Erbium-doped fiber amplifiers (cont.)

- Amplification is achieved by quantum mechanical phenomenon of stimulated emission
 - erbium atoms are excited to a high energy level by pump laser signal
 - they fall to a lower metastable (long-lived, 10 ms) state
 - an arriving photon triggers (stimulates) a transition to the ground level and another photon of the same wavelength is emitted

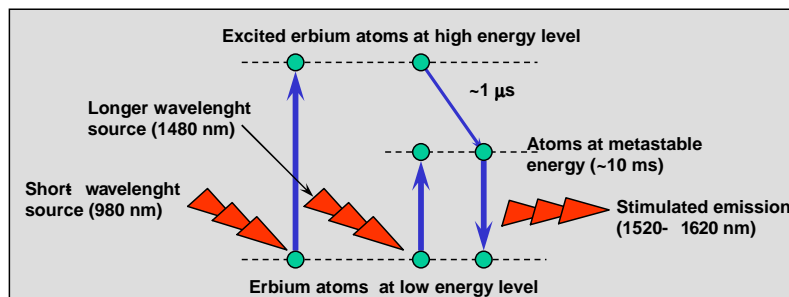

Erbium-doped fiber amplifiers (cont.)

- EDFAs have a high pump power utilization (> 50 %).
- Directly and simultaneously amplify a wide wavelength band (> 80 nm in the region 1550 nm) with a relatively flat gain
- Flatness of gain can be improved with gain-flattening optical filters
- Gain in excess of 50 dB
- Saturation power is as high as 37 dBm
- Low noise figure
- Transparent to optical modulation format
- Polarization independent
- Suitable for long-haul applications
- EDFAs are not small and cannot easily be integrated with other semiconductor devices

Wavelength converters

Wavelength converters

- Enable optical channels to be relocated
- Achieved in optical domain by employing nonlinear phenomena

Types of wavelength converters

- Optoelectronic approach
- Optical gating - cross-gain modulation
- Four-wave mixing

Wavelength converters - optoelectronic approach

- Simplest approach
- Input signal is
 - received
 - converted to electronic form
 - regenerated
 - transmitted using a laser at a different wavelength.

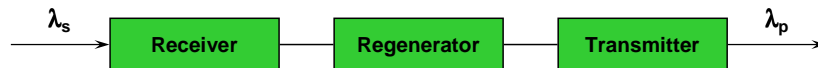

Optical gating - cross-gain modulation

- Makes use of the dependence of the gain of a SOA (semiconductor optical amplifier) on its input power
- Gain saturation occurs when high optical power is injected
 - carrier concentration is depleted
 - gain is reduced
- Fast
 - can handle 10 Gbit/s rates

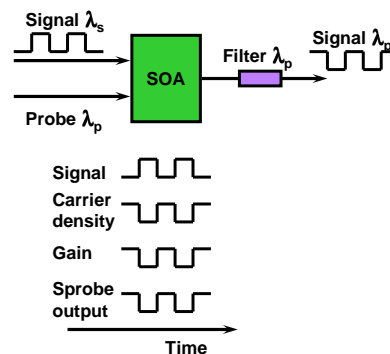

Four-wave mixing

- Four-wave mixing is usually an undesirable phenomenon in fibers
- Can be exploited to achieve wavelength conversion
- In four-wave mixing, three waves at frequencies f_1 , f_2 and f_3 produce a wave at the frequency $f_1 + f_2 - f_3$
- When
 - $f_1 = f_s$ (signal)
 - $f_2 = f_3 = f_p$ (pump)
=> a new wave is produced at $2f_p - f_s$
- Four-wave mixing can be enhanced by using SOA to increase the power levels
- Other wavelengths are filtered out

Four-wave mixing (cont.)

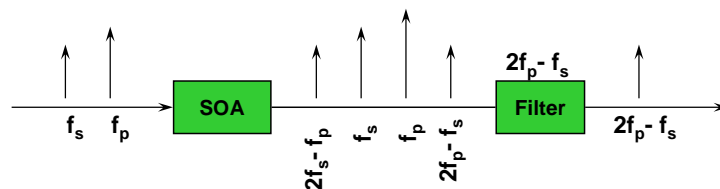

Optical multiplexers and demultiplexers

- An optical multiplexer receives many wavelengths from many fibers and converges them into one beam that is coupled into a single fiber
- An optical demultiplexer receives a beam (consisting of multiple optical frequencies) from a fiber and separates it into its frequency components, which are directed to separate fibers (a fiber for each frequency)

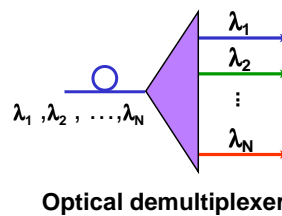
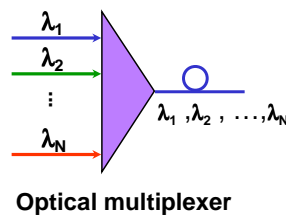

Prisms and diffraction gratings

- Prisms and diffraction gratings can be used to achieve these functions in either direction (reciprocity)
 - in both of these devices, a polychromatic parallel beam impinging on the surface is separated into frequency components, which leave the device at different angles
 - based on different refraction (prism) or diffraction (diffraction grating) of different wavelengths

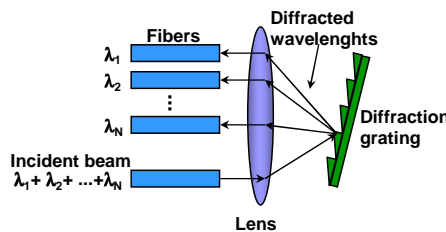
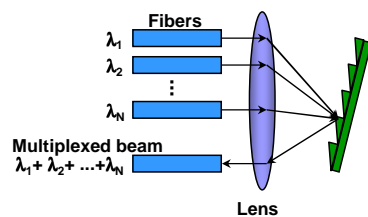

Prisms and diffraction gratings (cont.)

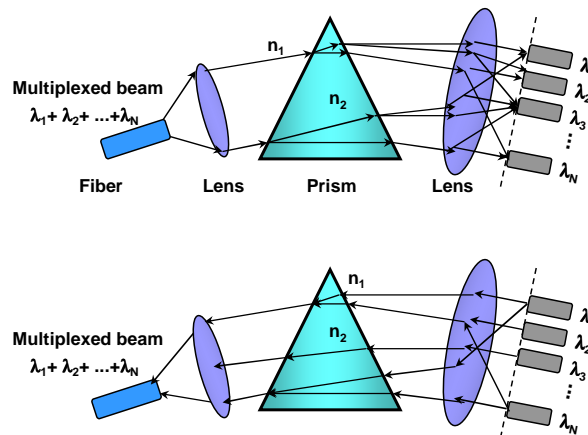

Arrayed waveguide grating (AWG)

- AWGs are integrated devices based on the principle of interferometry
 - a multiplicity of wavelengths are coupled to an array of waveguides with different lengths
 - produces wavelength dependent phase shifts
 - in the second cavity the phase difference of each wavelength interferes in such a manner that each wavelength contributes maximally at one of the output fibers
- Reported systems
 - SiO₂ AWG for 128 channels with 250 GHz channel spacing
 - InP AWG for 64 channels with 50 GHz channel spacing

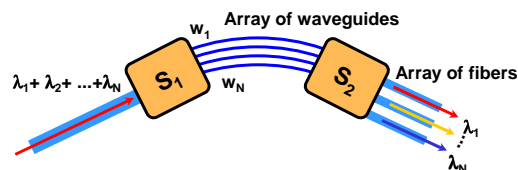

Optical add-drop multiplexers (OADM)

- Optical multiplexers and demultiplexers are components designed for wavelength division (WDM) systems
 - multiplexer combines several optical signals at different wavelengths into a single fiber
 - demultiplexer separates a multiplicity of wavelengths in a fiber and directs them to many fibers
- The optical add-drop multiplexer
 - selectively removes (drops) a wavelength from the multiplex
 - then adds the same wavelength, but with different data

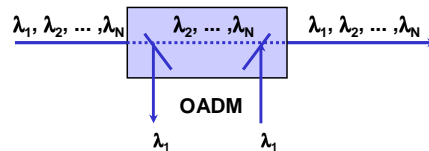

Optical add-drop multiplexers (cont.)

- An OADM may be realized by doing full demultiplexing and multiplexing of the wavelengths
 - a demultiplexed wavelength path can be terminated and a new one created

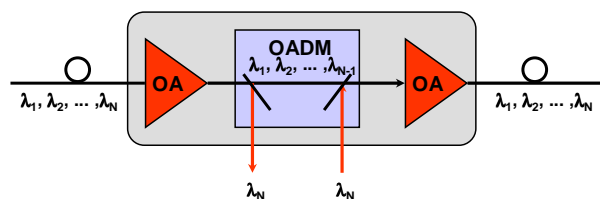

Optical cross-connects

- Channel cross-connecting is a key function in communication systems
- Optical cross-connection may be accomplished by
 - **hybrid approach**: converting optical signal to electronic domain, using electronic cross-connects, and converting signal back to optical domain
 - **all-optical switching**: cross-connecting directly in the photonic domain
- Hybrid approach is currently more popular because the all-optical switching technology is not fully developed
 - all optical NxN cross-connects are feasible for $N = 2 \dots 32$
 - large cross-connects ($N \sim 1000$) are in experimental or planning phase
- All-optical cross-connecting can be achieved by
 - optical solid-state devices (couplers)
 - electromechanical mirror-based free space optical switching devices

Solid-state cross-connects

- Based on semiconductor directional couplers
- Directional coupler can change optical property of the path
 - polarization
 - propagation constant
 - absorption index
 - refraction
- Optical property may be changed by means of
 - heat, light, mechanical pressure
 - current injection, electric field
- Technology determines the switching speed, for instance
 - LiNbO₃ crystals: order of ns
 - SiO₂ crystals: order of ms

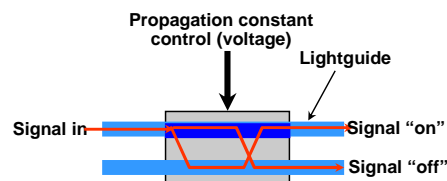

Solid-state cross-connects (cont.)

- A multiport switch, also called a star coupler, is constructed by employing several 2x2 directional couplers
- For instance, a 4x4 switch can be constructed from six 2x2 directional couplers
- Due to cumulative losses, the number of couplers in the path is limited and, therefore, also the number of ports is limited, perhaps to 32x32

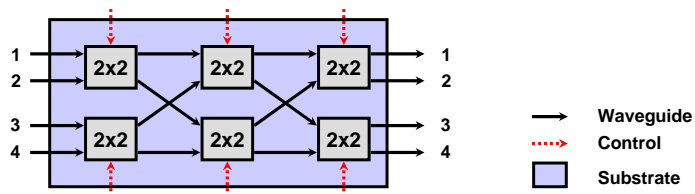

Microelectromechanical switches (MEMS)

- Tiny mirrors micromachined on a substrate
 - outgrowth of semiconductor processing technologies: deposition, etching, lithography
 - a highly polished flat plate (mirror) is connected with an electrical actuator
 - can be tilted in different directions by applied voltage

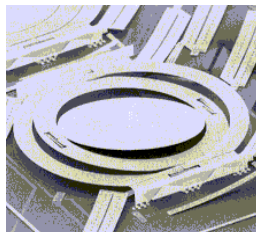

Optical cross connects

- MEMS technology is still complex and expensive.
- Many MEMS devices may be manufactured on the same wafer
 - reduces cost per system
- Many mirrors can be integrated on the same chip
 - arranged in an array
 - experimental systems with $16 \times 16 = 256$ mirrors have been built
 - each mirror may be independently tilted
- An all-optical space switch can be constructed using mirror arrays

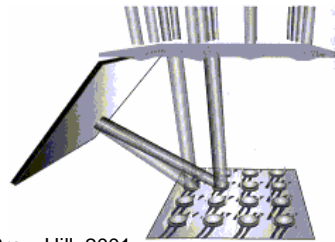

R.J. Bates, *Optical switching and networking handbook*, McGraw-Hill, 2001

Optical switches

- Components and enabling technologies
- **Contention resolution**
- Optical switching schemes

Contention resolution

- Contention occurs when two or more packets are destined to the same output at the same time instant
- In electronic switches, contention solved usually by store-and-forward techniques
- In optical switches, contention resolved by
 - optical buffering (optical delay lines)
 - deflection routing
 - exploiting wavelength domain
 - scattered wavelength path (SCWP)
 - shared wavelength path (SHWP)

Optical delay loop

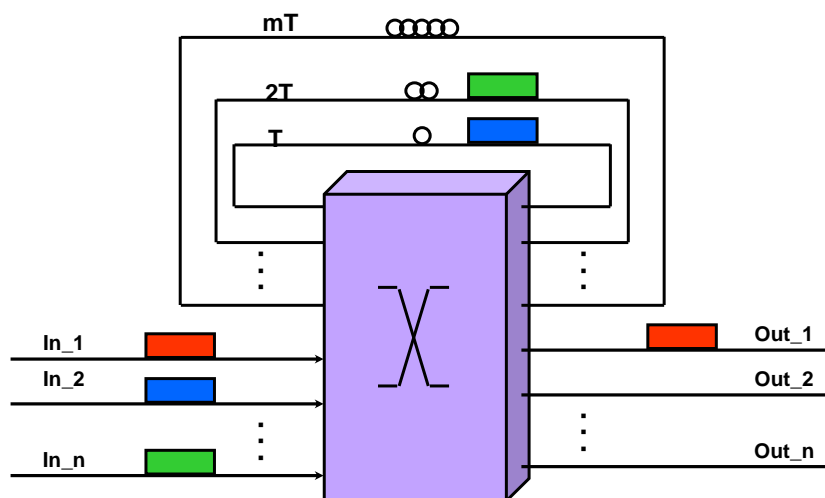

Deflection routing

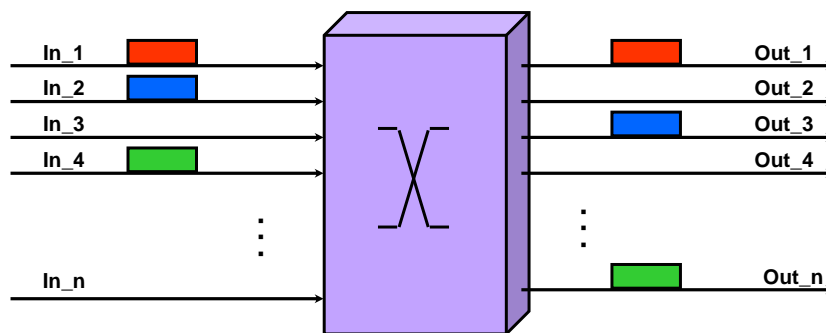

Wavelength conversion

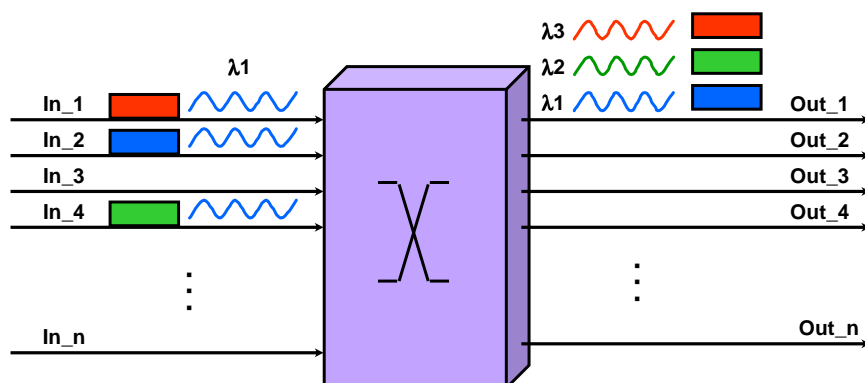

Optical switches

- Components and enabling technologies
- Contention resolution
- **Optical switching schemes**

Optical packet switching

- User data transmitted in optical packets
 - packet length fixed or variable
- Packets switched in optical domain packet-by-packet
- No optical-to-electrical (and reverse) conversions for user data
- Switching utilizes TDM and/or WDM
- Electronic switch control
- Different solutions suggested
 - broadcast-and-select
 - wavelength routing
 - optical burst switching

Optical packet switch

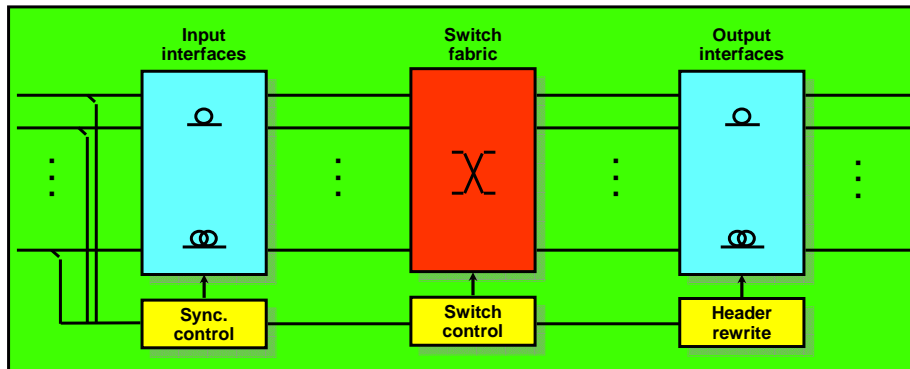

- packet delineation
- packet alignment
- header and payload separation
- header information processing
- header removal

- switching of packets from inputs to correct outputs in optical domain
- contention resolution

- header insertion
- optical signal regeneration

Broadcast-and-select

- Input ports support different wavelengths (e.g. only one wavelength/port)
- Data packets from all input ports combined and broadcast to all output ports
- Each output port selects dynamically wavelengths, i.e. packets, addressed to it
- Inherent support for multi-casting
- Requires that control unit has received routing/connection information before packets arrive

Broadcast-and-select

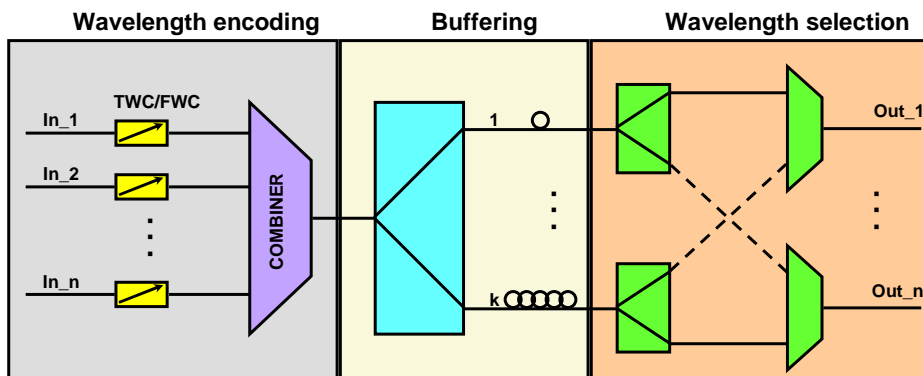

TWC - Tunable Wavelength Converter
FWC - Fixed Wavelength Converter

Wavelength routing

- Input ports usually support the same set of wavelengths
- Incoming wavelengths arrive to “contention resolution and buffering” block, where the wavelengths are
 - converted to other wavelenths (used inside the switch)
 - demultiplexed
 - routed to delay loops of parallel output port logics
- Contention free wavelengths of the parallel output port logics are combined and directed to “wavelength switching” block
- Wavelength switching block converts internally routed λ -channels to wavelengths used in output links and routes these wavelengths to correct output ports
- Correct operation of the switch requires that control unit has received routing/connection information before packets arrive

Wavelength routing

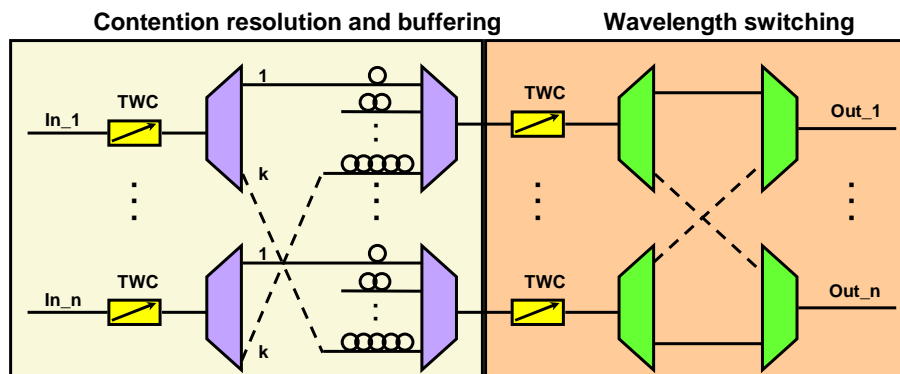

TWC - Tunable Wavelength Converter

Optical burst switching

- Data transmitted in bursts of packets
- Control packet precedes transmission of a burst and is used to reserve network resources
 - no acknowledgment, e.g. TAG (Tell-and-Go)
 - acknowledgment, e.g. TAW (Tell-and-Wait)
- High bandwidth utilization (lower avg. processing and synchronization overhead than in pure packet switching)
- QoS and multicasting enabled

Header and packet formats

- In electronic networks, packet headers transmitted serially with the payload (at the same bit rate)
- In optical networks, bandwidth is much larger and electronic header inspection cannot be done at wire speed
- Header cannot be transmitted serially with the payload
- Different approaches for optical packet format
 - packets switched with sub-carrier multiplexed headers
 - header and payload transmitted in different λ -channels
 - header transmitted ahead of payload in the same λ -channel
 - tag (λ) switching - a short fixed length label containing routing information

Header and packet formats (cont.)

Packets with sub-carrier headers

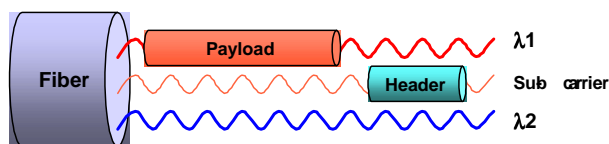

Header and payload in different λ -channels

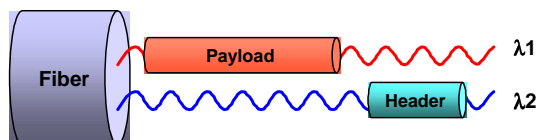

Header transmitted ahead of payload in the same λ -channel

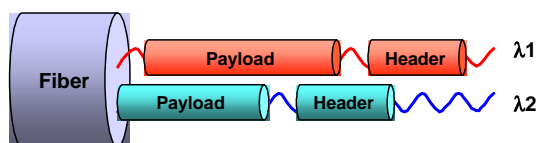

Example optical packet format (KEOPS)

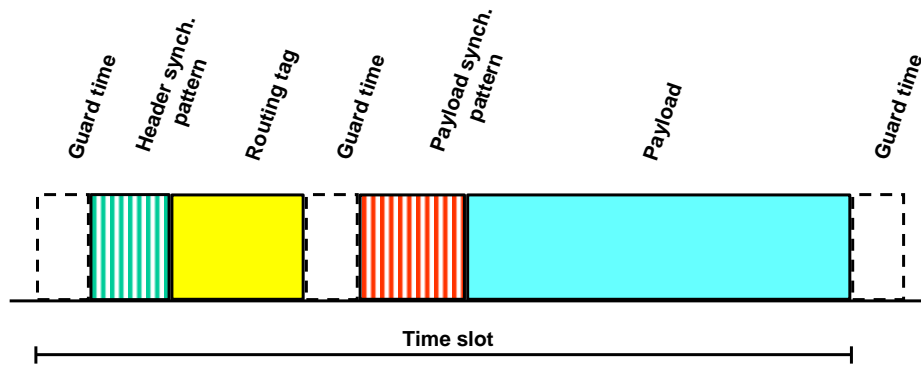

Research issues in optical switching

- Switch fabric interconnection architectures
- Packet coding techniques (bit serial, bit parallel, out-of-band)
- Optical packet structure (fixed vs. variable length)
- Packet header processing and insertion techniques
- Contention resolution techniques
- Optical buffering (delay lines, etc.)
- Reduction of protocol layers between IP and fiber
- Routing and resource allocation (e.g. GMPLS, RSVP-TE)
- Component research (e.g. MEMS)